

- Data processing general issues : Data flow, processing budget and SGS organization
- Swiss Science Data Center tasks
- Operation model and preparation

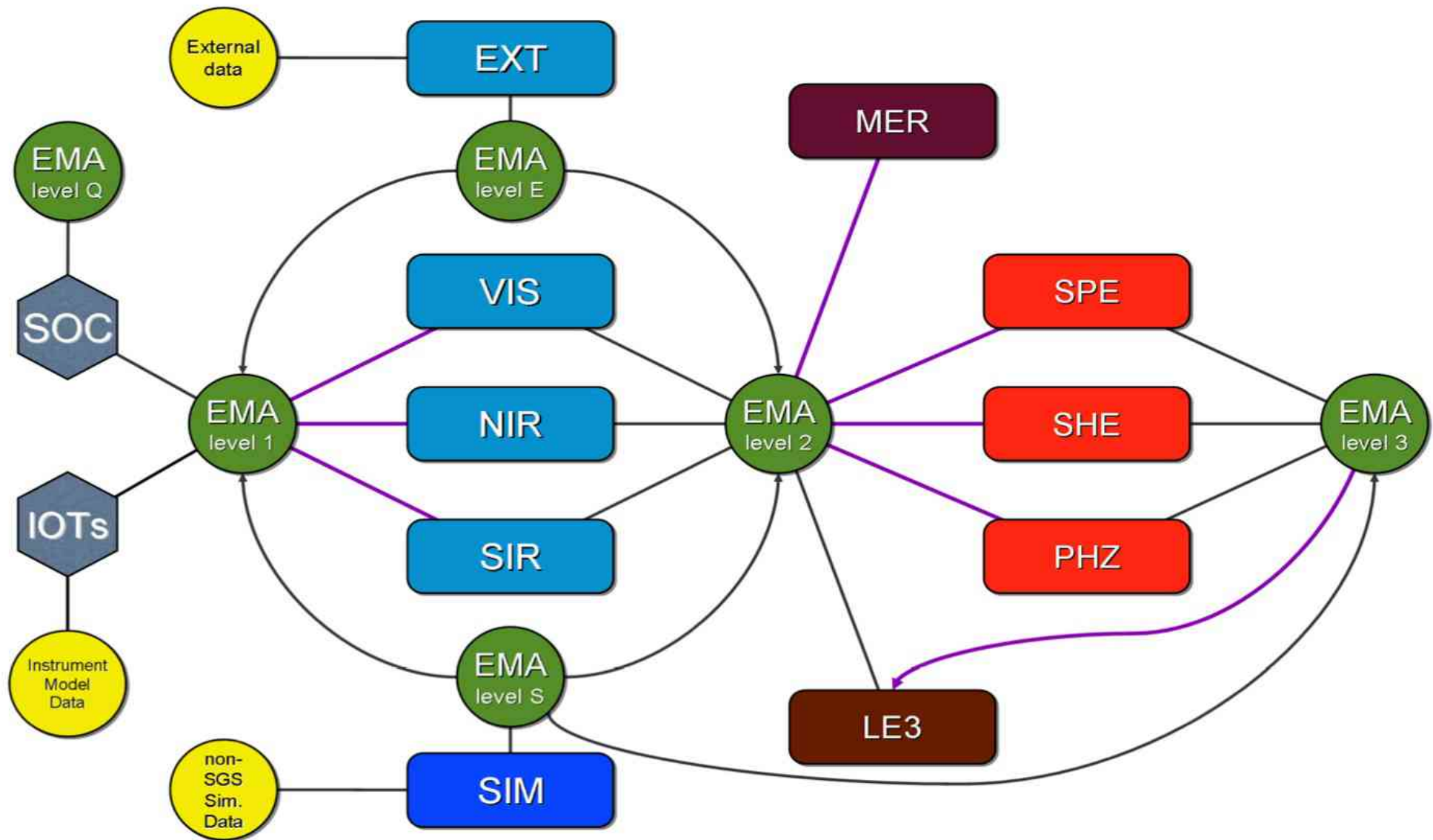

- VIS
 - Visual Imaging (550-900 nm) down to 24.5 mag
 - Array of 36 (4K x 4K) CCDs with 0.1" pixels
 - FoV: $0.78 \times 0.71 = 0.54 \text{ deg}^2$
- NISP
 - NIR imaging (JHK to 24 mag) and slitless spectroscopy
 - Array of 16 (2kx2k) HgCdTe detectors with 0.3" pixels
 - ~same FoV
- 5 to 7 years mission

Ground processing organization



The Euclid data flow

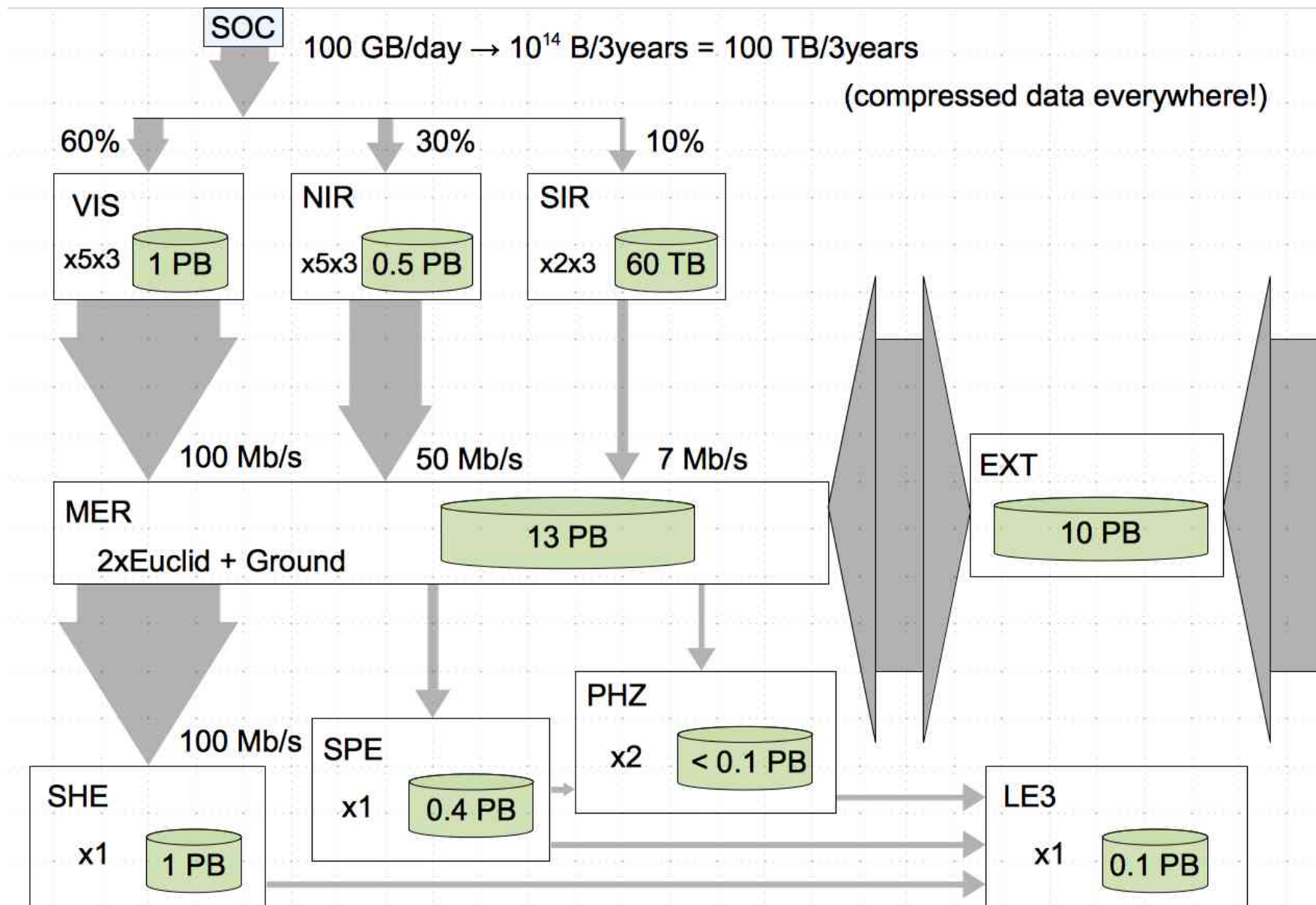

Processing budget

		2021	2022	2023	2024	2025	2026	2027
			DR1		DR2			DR3
Post launch L1/L2 processing	Storage (TB)	15227	30454	45680	60906	76132	91359	91359
	Computing (core x year)	2097	4192	6288	8384	10479	12575	12575
Post launch L3 * processing (DR)	Computing (core x year)	450	910	2000	3400	5000	6800	8440
Post launch simulations	Storage (TB)	618	618	618	618	618	618	618
	Computing (core x year)	100	100	100	100	100	100	100
Total	Storage (TB)	15845	31072	46298	61524	76750	91977	91977
	Computing (core x year)	2647	5202	8388	11884	15579	19475	21115

Ground processing organization

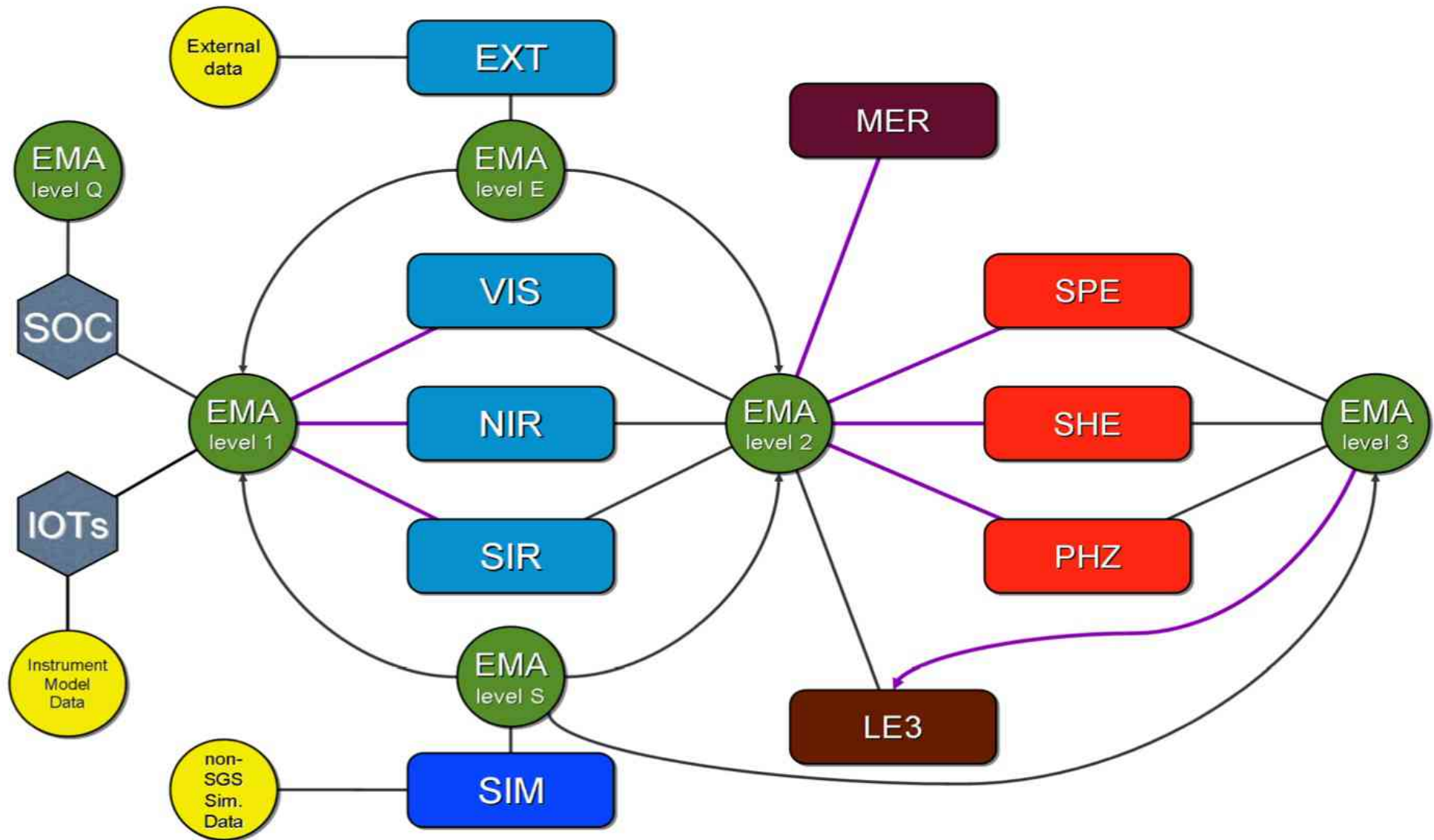

Euclid SGS organization

EUCLID
CONSORTIUM

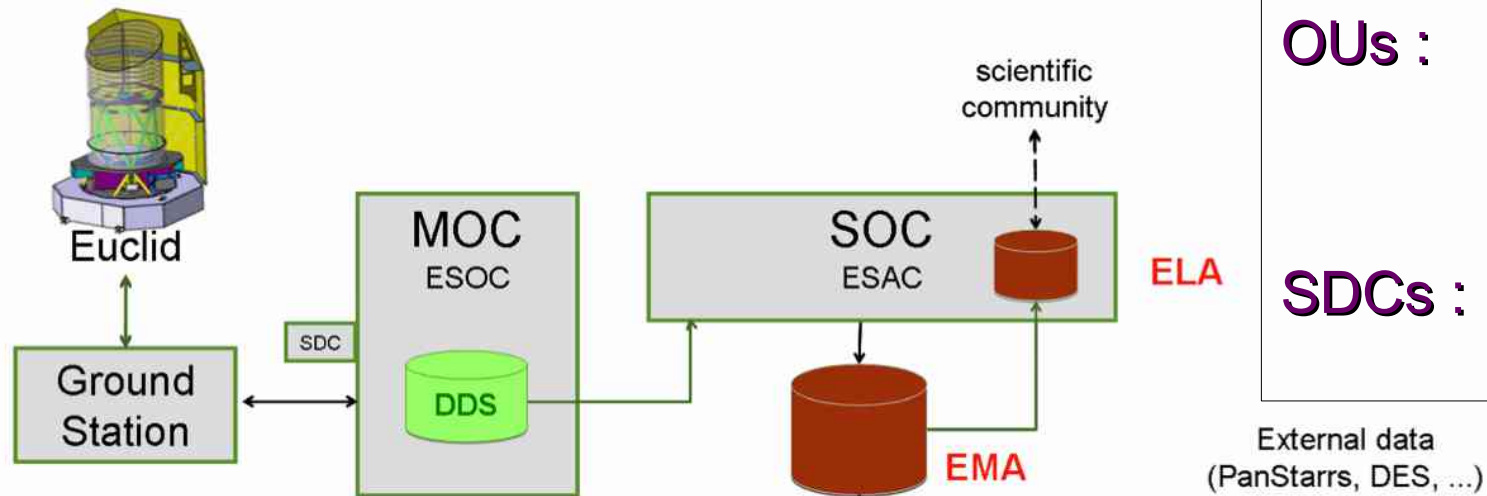

OUs : Algorithms specification & validation

SDCs : Software dev. Data processing

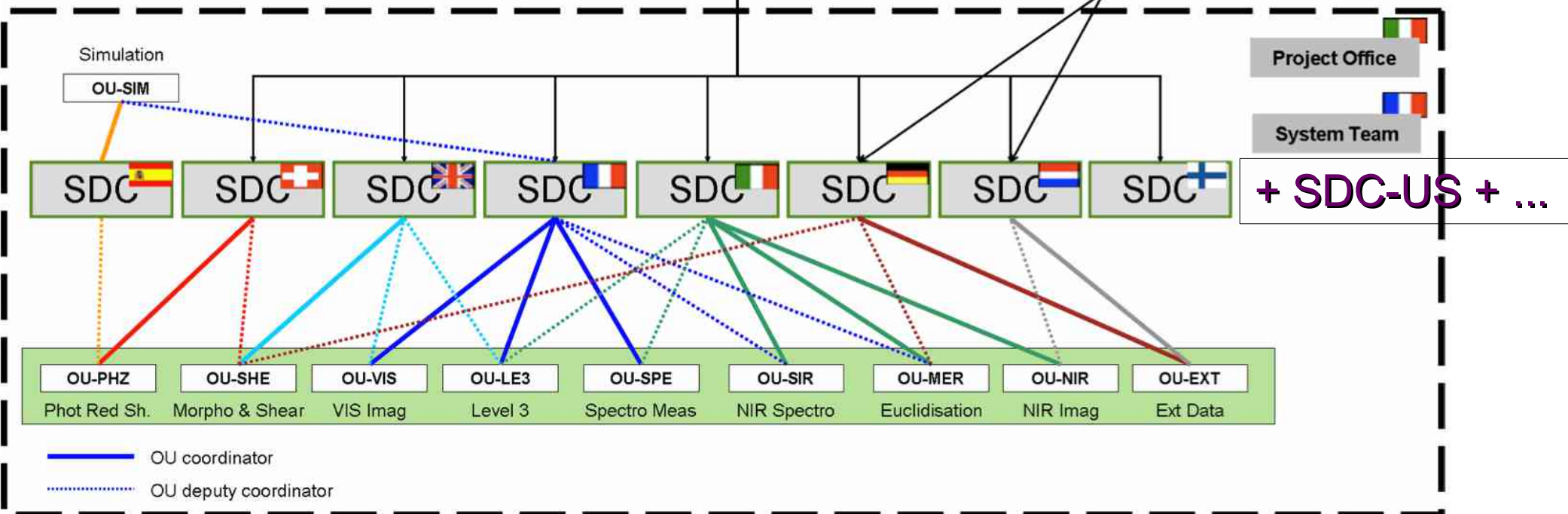

- Functional responsibilities
 - Photometric redshift determination (billions of sources)
 - Strong lenses automatic detection
- Specifications provided by OU colleagues
 - OU-PHZ (Stéphane Paltani)
 - OU-SHE (Frédéric Courbin)
- Software developments, from design to integration tests, incremental / iterative approach (Agile methodology)
- Validation in collaboration with OU colleagues
- Contribution to common task (System Team)
- Contribution to the operations after 2021

- C++ and Python languages
- A single reference platform in a virtual machine (LODEEN)
 - Linux (CentOS7)
 - Procedure to control the set of libraries/tools
 - RPM packages
- All (most!) software to be integrated in common Euclid pipelines
- Processing distributed on all SDCs, with a “central” control system (COOR, IAL, DSS)

- Elements : C++ and Python building and packaging framework
- Alexandria : C++ common library
- Phosphoros : C++ implementation of a template fitting photometric redshift algorithm
- Machine learning for photometric redshift determination
- Strong lensing algorithm exploration (Python)
- SExtractor framework
- Spectroscopic database
- Data processing challenge #6 on-going

Phosphoros challenge results

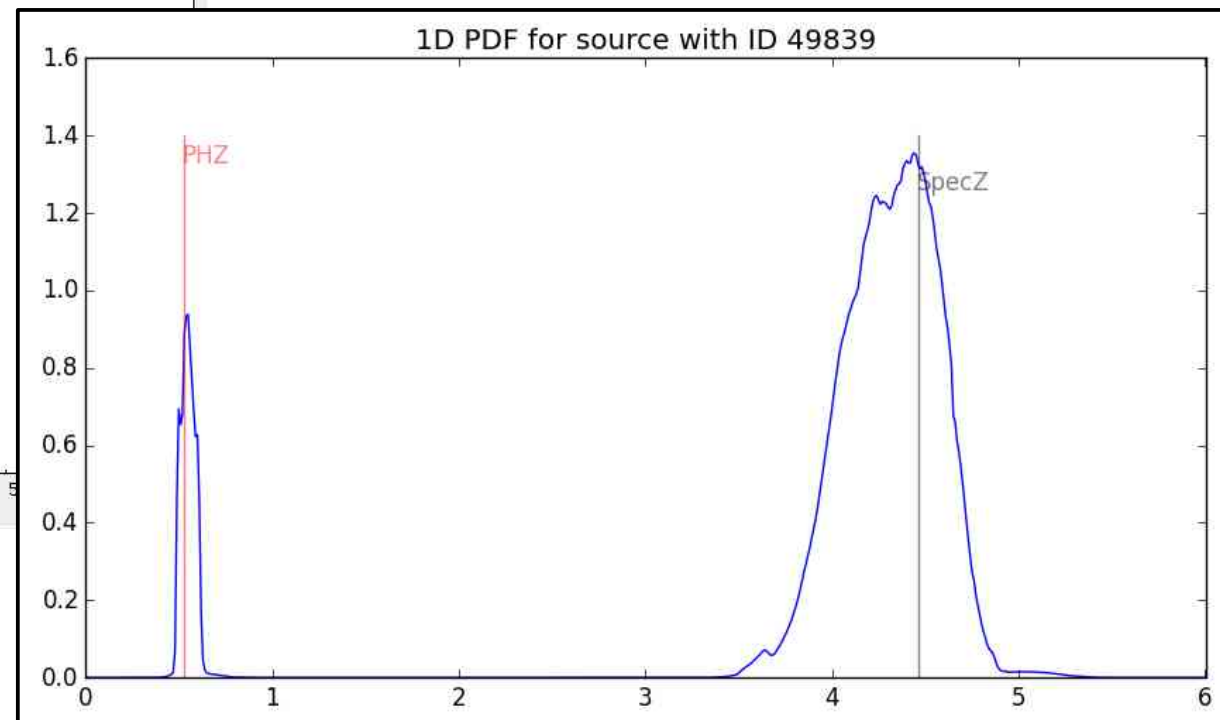
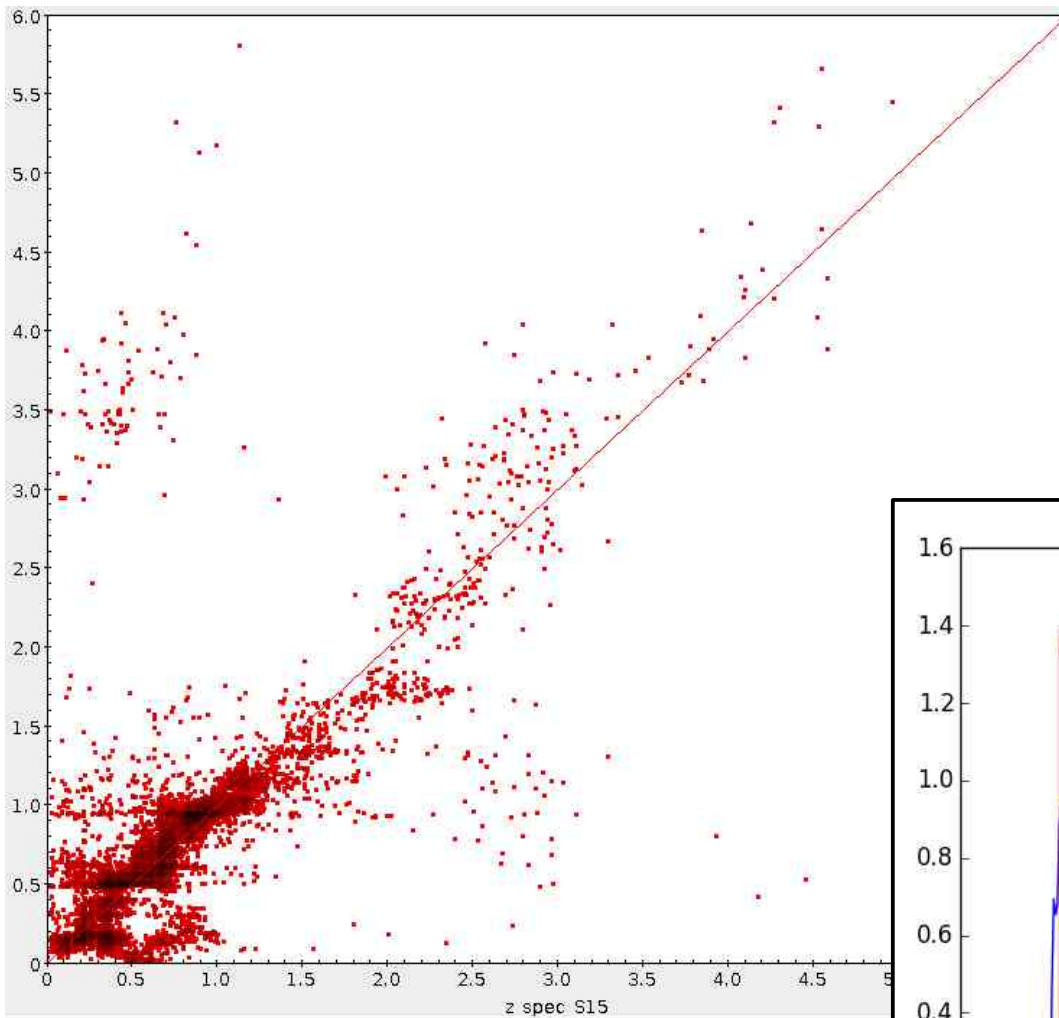

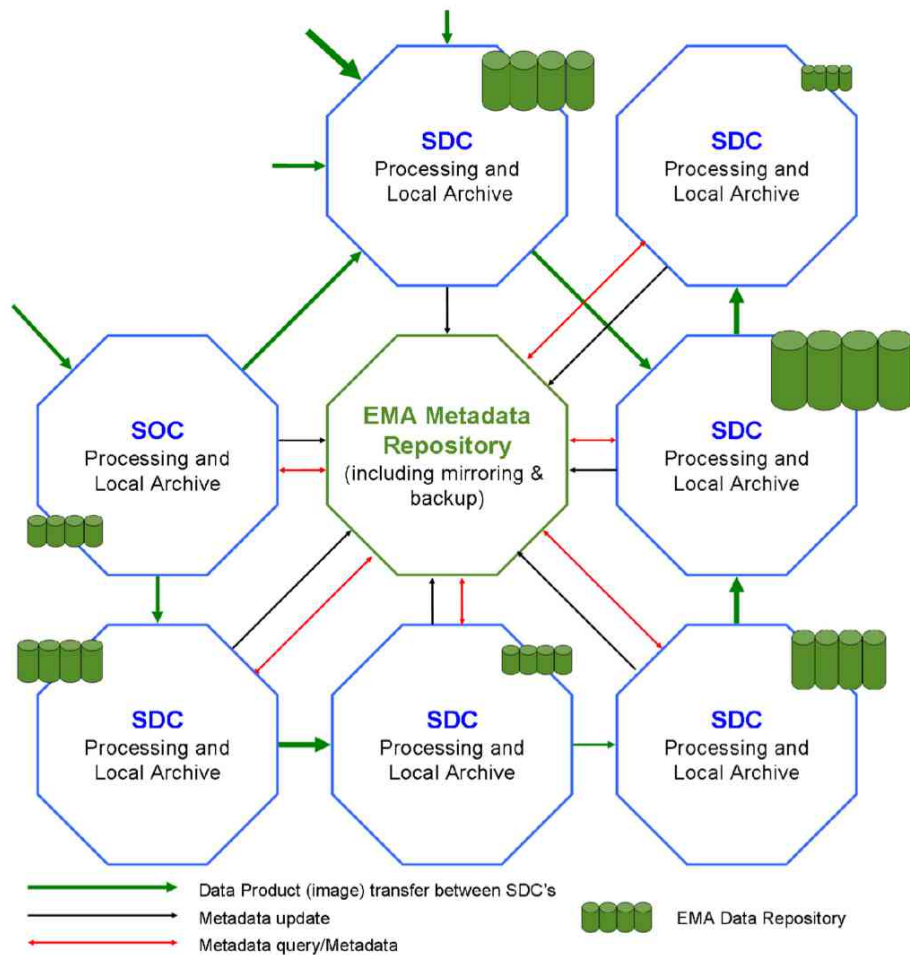

- Involve 10 SDCs
- Metadata database
- In each SDC
 - Managment software
 - PC cluster (HPC)
- System build up through a series of “challenges”

Challenge 6 as an example

